

PRINCIPAL PARTICULARS

LOA	280'-0" (85.34m)
BREADTH	60'-0" (18.29m)
DEPTH	24'-0" (7.32m)
DRAFT (LOADLINE)	19'-3" (5.87m)
CLEAR DECK CARGO SPACE	201' X 50.5' (61.27m X 15.40m)
CLEAR DECK CARGO AREA	10,151 ft ² (943 m ²)
CARGO DECK RATING	1,200 lb/ft ² (6 MT/m ²)
MAIN PROPULSION	(2) X C280-8 CATERPILLAR, 3,299 BHP @ 1,000 RPM EACH
BOW THRUSTER-TUNNEL	1 X 1,700 HP BRUNVOLL CPP TUNNEL (ELECTRIC DRIVEN) 1,250 KW
BOW THRUSTER-SWING	1 X 1,200 HP ROLLS ROYCE TONS 73/50 SWING UP (3508 CAT)
STERN THRUSTER-TUNNEL	1 X 1,700 HP BRUNVOLL CPP TUNNEL (ELECTRIC DRIVEN) 1,250 KW
SHIPS SERVICE DIESEL GENERATOR	2 X 910 kw (3508B CAT)
SHAFT GENERATOR FOR ELECTRIC THRUSTERS	2 X 2 mW (KATO)
EMERGENCY DIESEL GENERATOR	1 X 175 kw (JOHN DEERE 6081AFM75)

ACCOMMODATIONS

2P CREW STATEROOMS	8
4P CREW STATEROOMS	3
1P CREW STATEROOMS	1
TOTAL BERTHING:	29

REGULATORY

SOLAS 2002, USCG SUBCHAPTER L, USCG MINIMALLY MANNED ENGINE ROOM, USCG OIL RECOVERY VESSEL AUTHORIZATION (20% DWT)
ABS LOADLINE, A1, AMS, DPS-2, ACP, ©

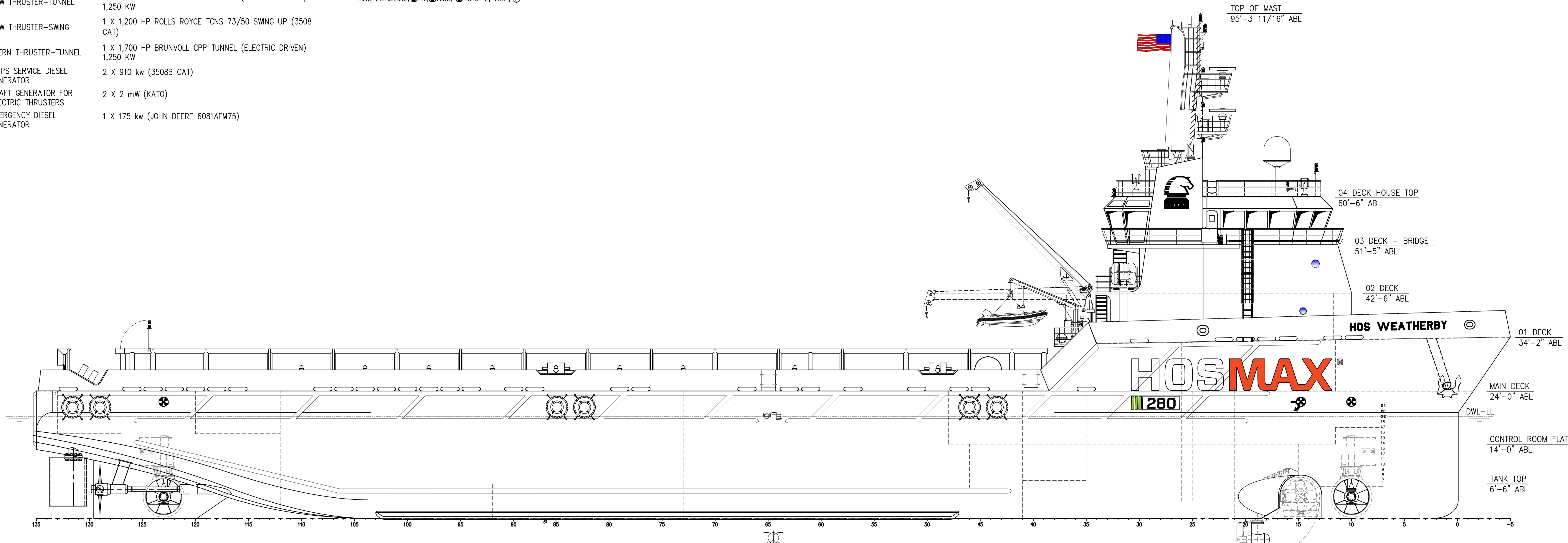

OUTBOARD PROFILE
STBD SIDE SHOWN, LKG PORT

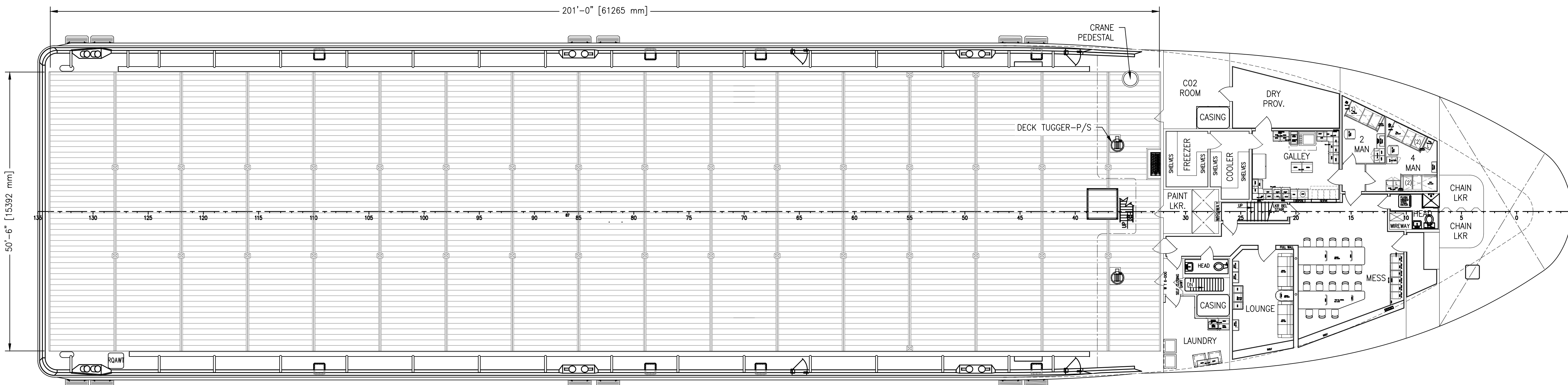

MAIN DECK PLAN
24'-0" ABL

HOSMAX 280 / HOS WEATHERBY			
<small>THIS DRAWING, DESIGN CONCEPT AND SPECIFICATIONS ARE THE PROPERTY OF HORNBECK OFFSHORE SERVICES AND ARE FURNISHED ON A CONFIDENTIAL BASIS WITH AN EXPRESSED UNDERSTANDING THAT THEY WILL NOT BE COPIED IN ANY MANNER USED FOR MANUFACTURE, SOLD, TRANSFERRED, NOR USED TO THE DETRIMENT OF SAID FIRM WITHOUT WRITTEN PERMISSION. 1008 ©</small>			
HORNBECK OFFSHORE SERVICES			
DRAWN BY: E. GRISHMAN	280'-0" X 60'-0" X 24'-0"		
CHECKED BY: M. STANSBURY	OUTBOARD PROFILE & GENERAL ARRANGEMENT		
APPROVED BY: J. GUIDRY	TASK No. 7582	DRAWING No. 1.001	SCALE: 3/32" = 1'-0" DATE: 05/22/23 SHEET 1 OF 3
HULL No. 248		SY: NAS	REV. 0
LAST SAVE/PLOT: 11/15/2023 8:43 AM		ENR: JSULLIVA	
SHEET: ANSI D 22X34		1	

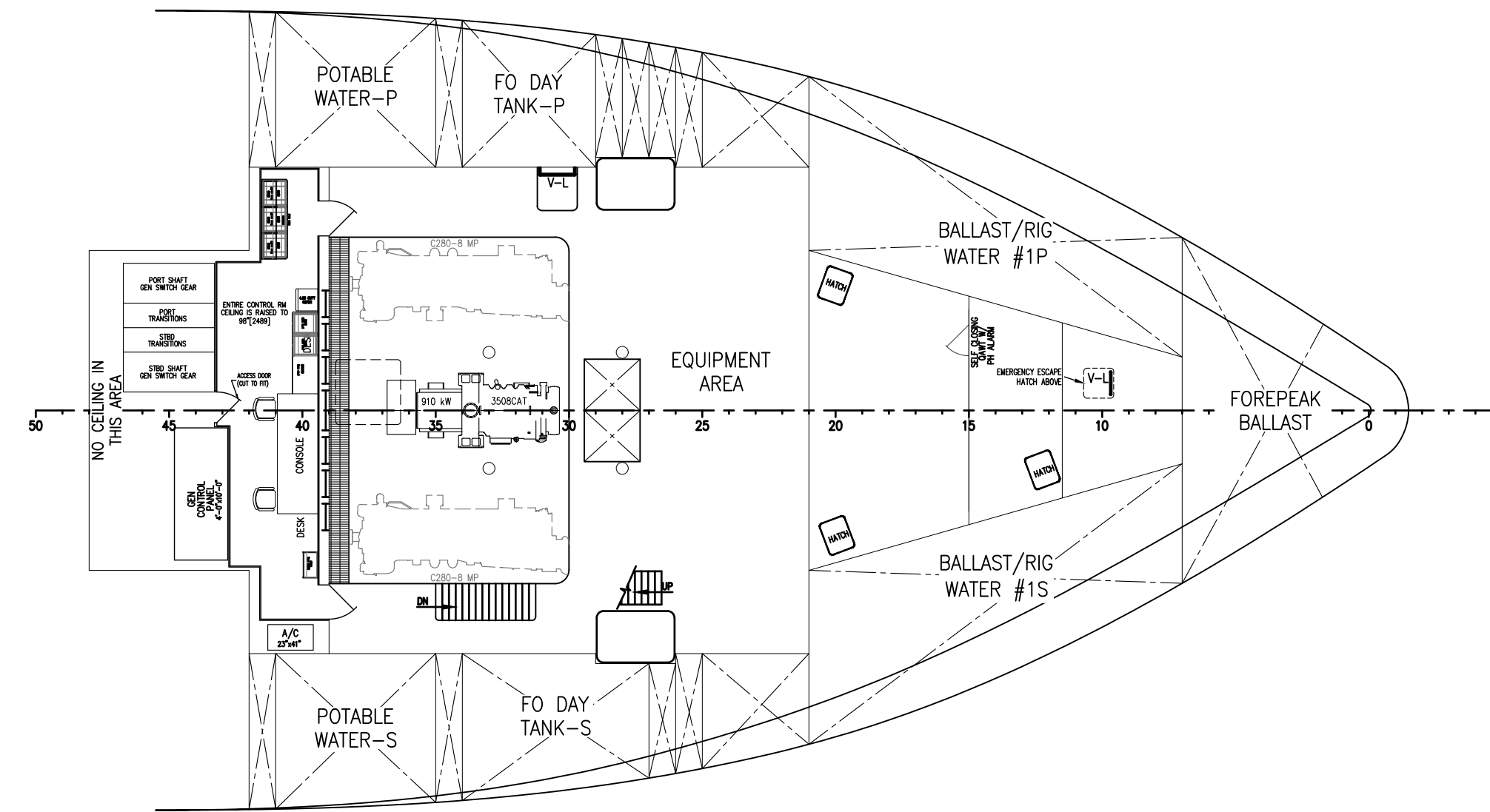

CONTROL ROOM FLAT PLAN

14'-0" ABL

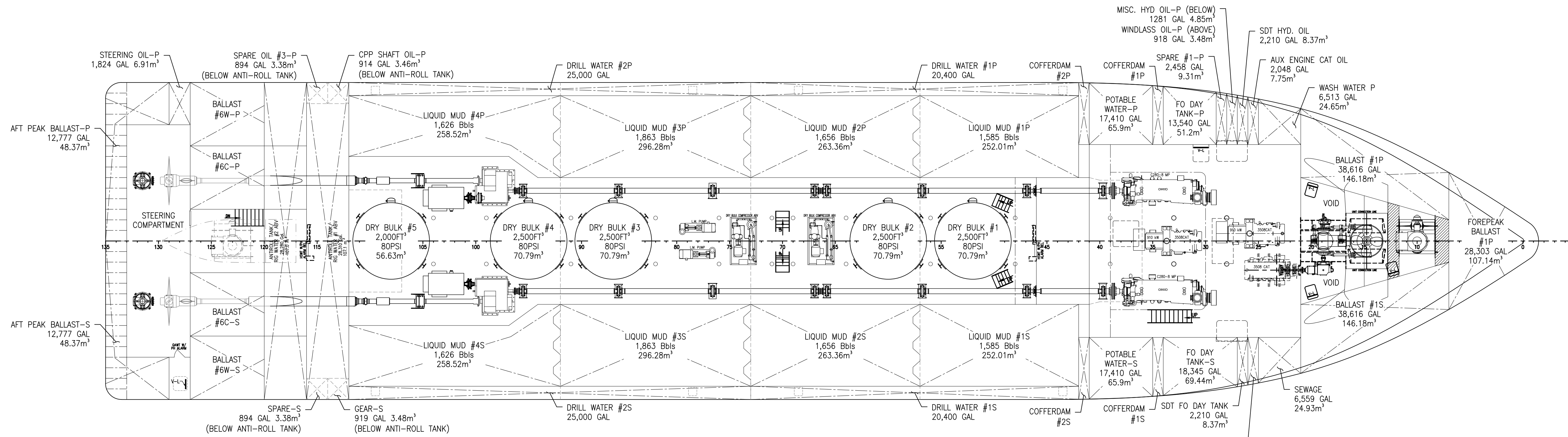

TANK TOP PLAN

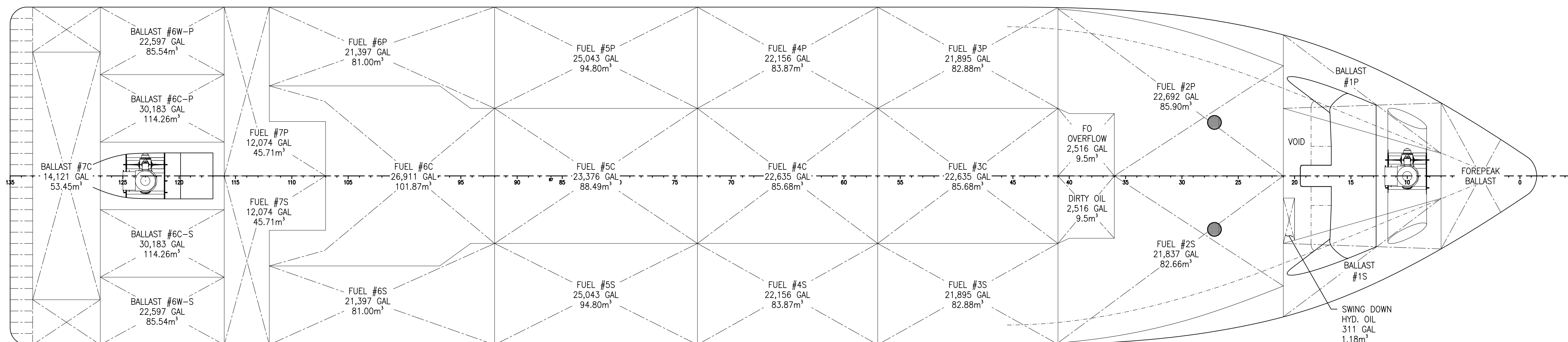

BELOW TANK TOP PLAN

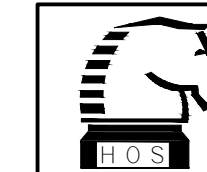

THIS DRAWING, DESIGN CONCEPT AND SPECIFICATIONS ARE THE PROPERTY OF HORNBECK OFFSHORE SERVICES AND ARE FURNISHED ON A CONFIDENTIAL BASIS WITH AN EXPRESSED UNDERSTANDING THAT THEY WILL NOT BE COPIED IN ANY MANNER USED FOR MANUFACTURE, SOLD, TRANSFERRED, NOR USED TO THE DETRIMENT OF SAID FIRM WITHOUT WRITTEN PERMISSION.

HORNBECK OFFSHORE SERVICES

OUTBOARD PROFILE & GENERAL ARRANGEMENT		SIZE
TASK No. 7582	DRAWING No. 1.001	D
HULL No. 248	SY: NAS	REV. 0
SCALE: 3/32" = 1'-0"		
DATE: 05/22/23		
SHEET 2 OF 3		

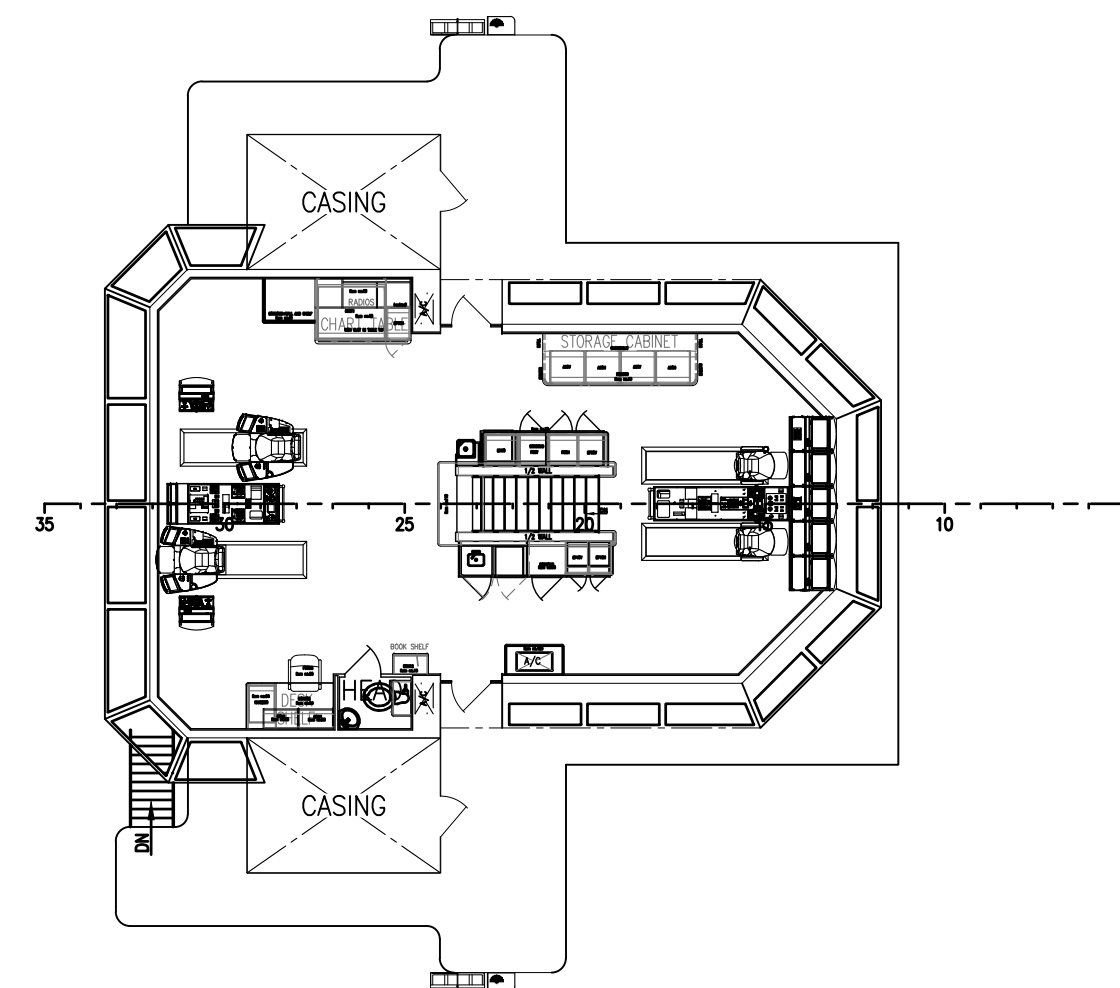

03 DECK – BRIDGE PLAN
51'-5" ABL

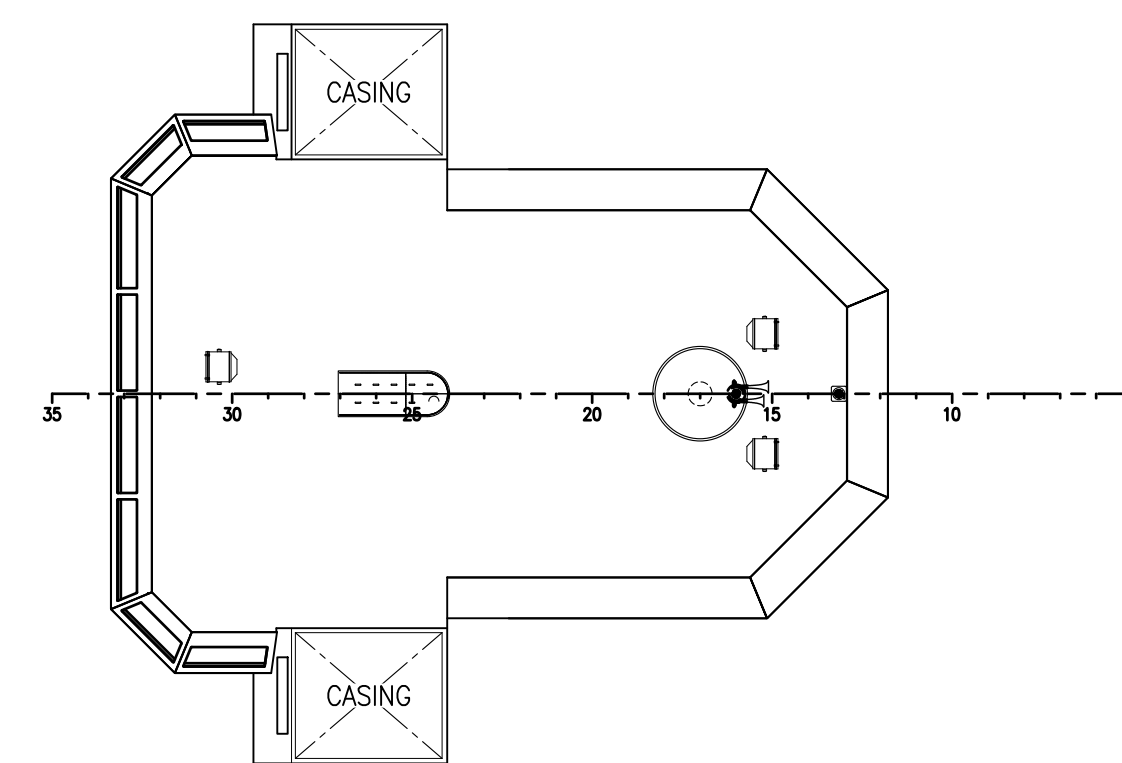

04 DECK – PILOT HOUSE TOP PLAN
60'-6" ABL

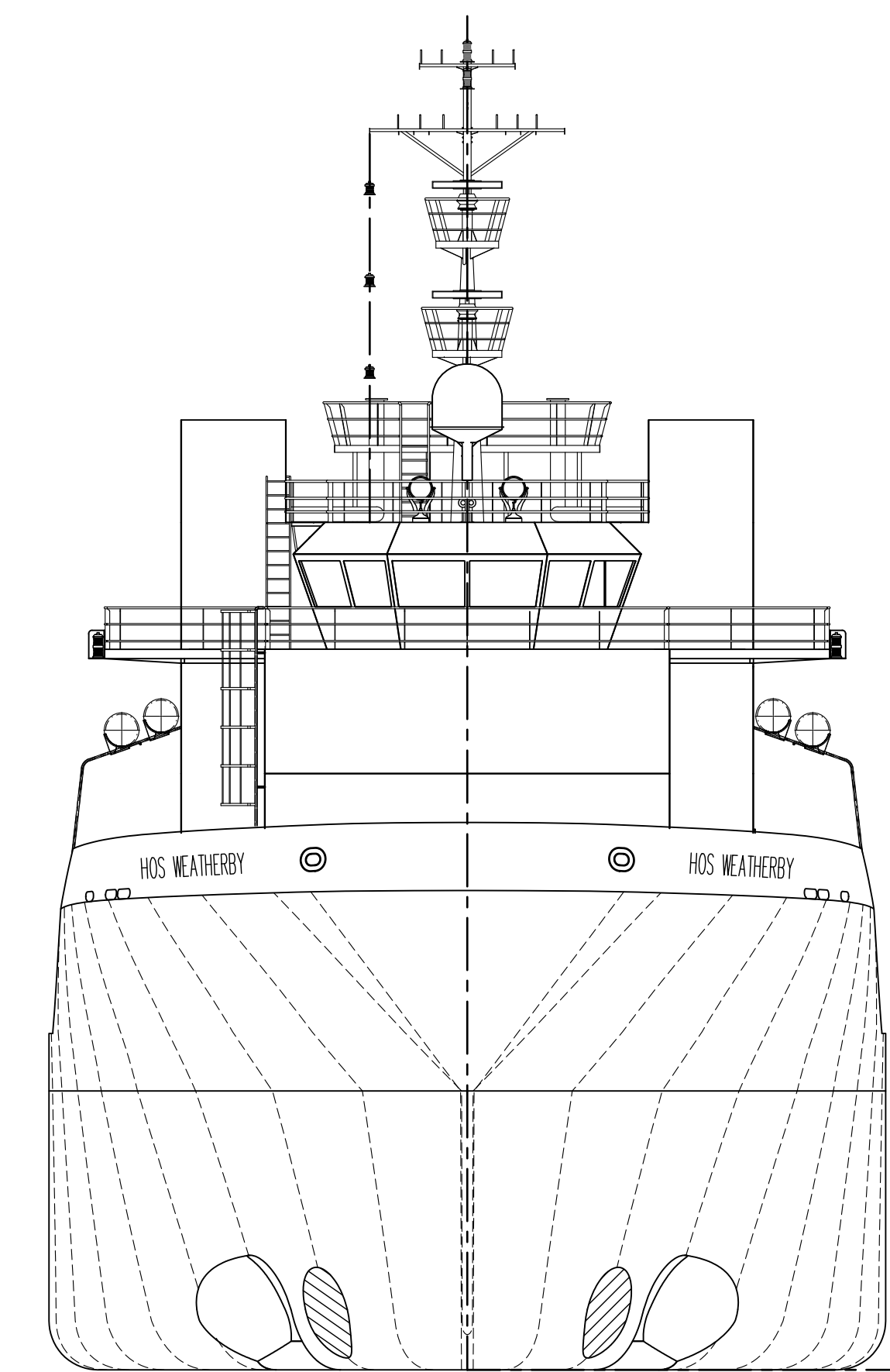

FRONT VIEW
BOW SHOWN, LKG AFT

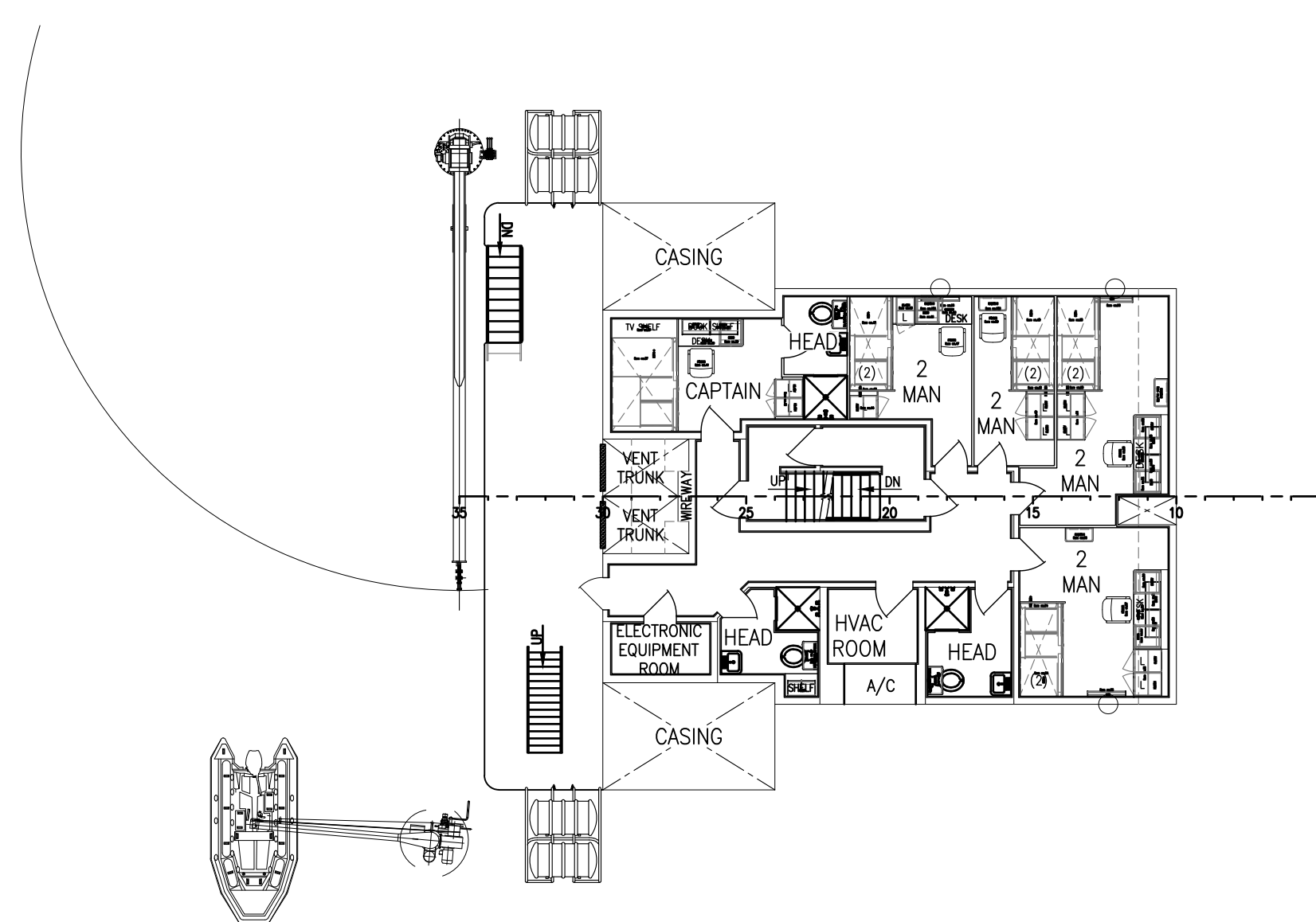

02 DECK PLAN
42'-6" ABL

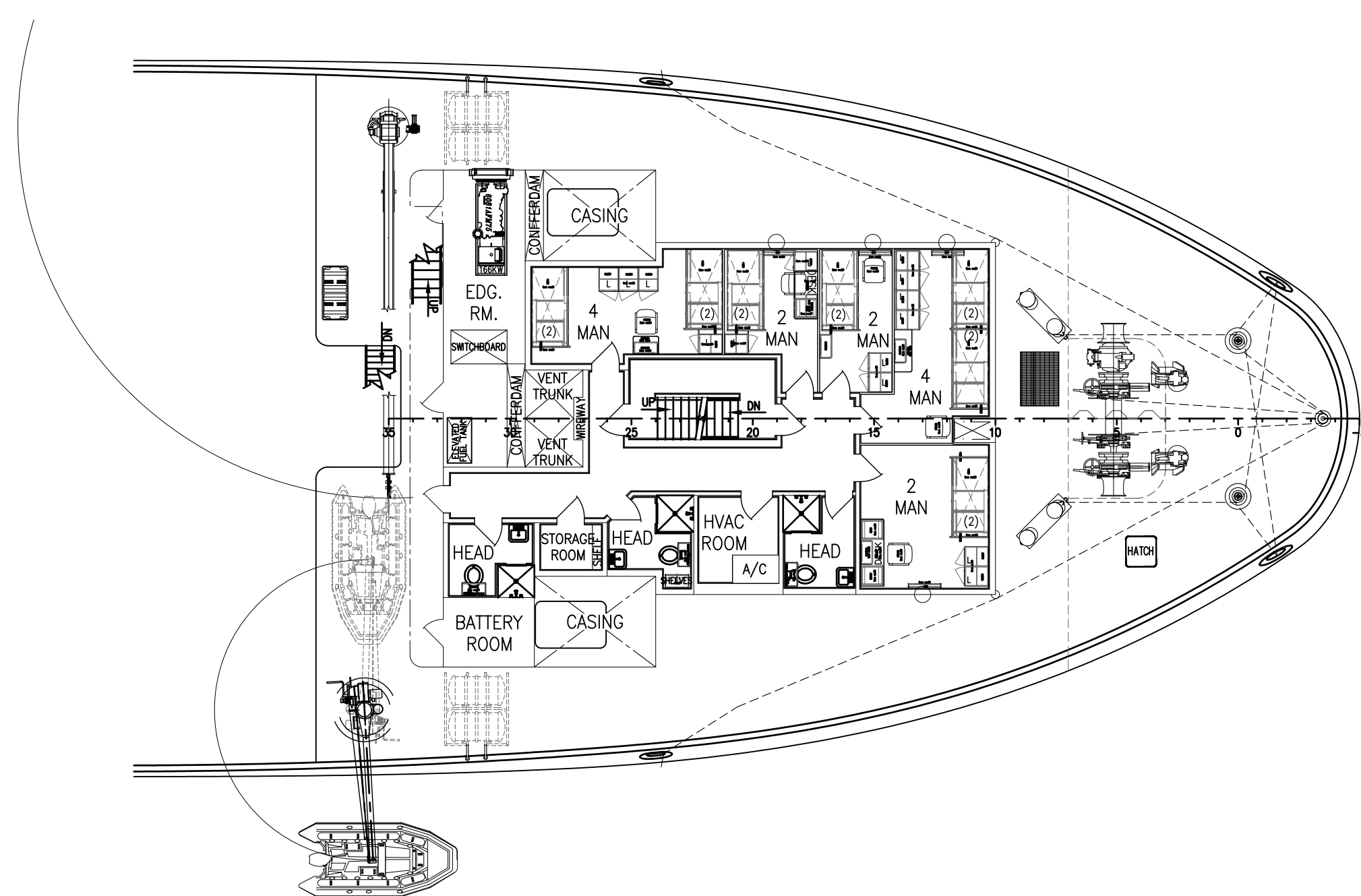

01 DECK PLAN
34'-2" ABL

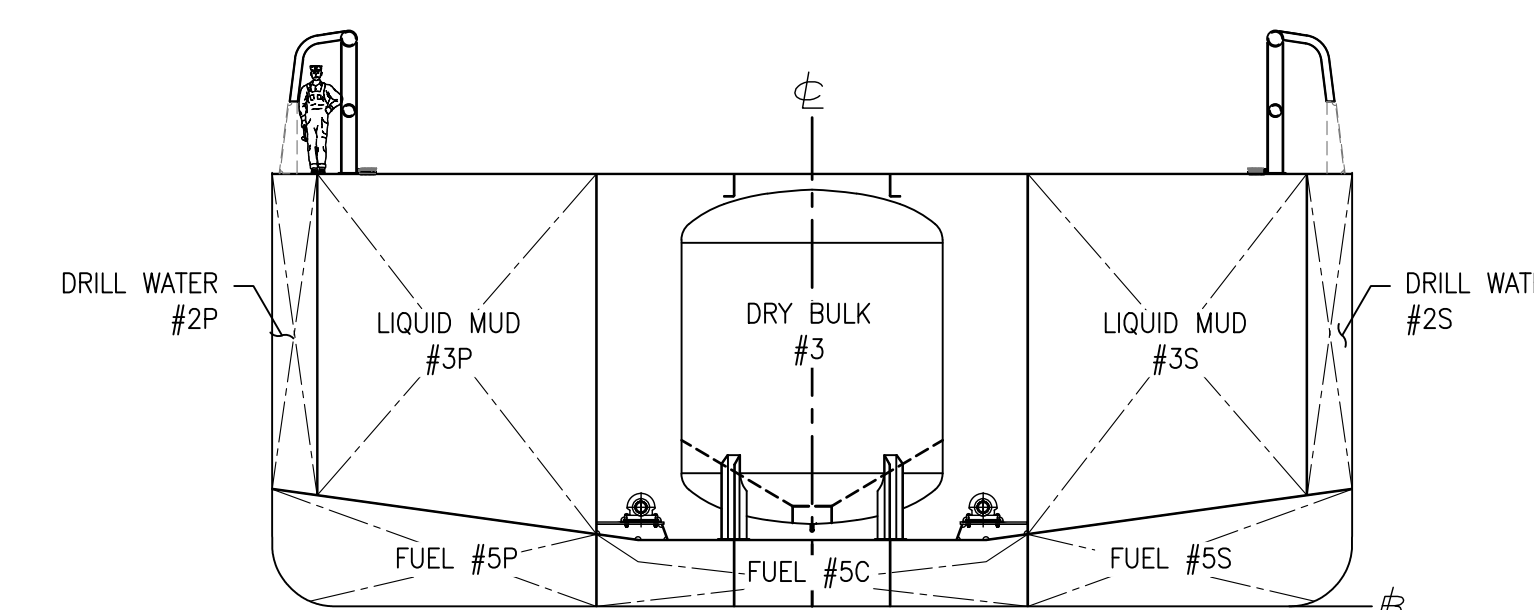

CARGO SECTION
FR85 LKG FWD

	<small>THIS DRAWING, DESIGN CONCEPT AND SPECIFICATIONS ARE THE PROPERTY OF HORNBECK OFFSHORE SERVICES AND ARE FURNISHED ON A CONFIDENTIAL BASIS WITH AN EXPRESSED UNDERSTANDING THAT THEY WILL NOT BE COPIED IN ANY MANNER USED FOR MANUFACTURE, SOLD, TRANSFERRED, NOR USED TO THE DETRIMENT OF SAID FIRM WITHOUT WRITTEN PERMISSION.</small>			<small>SIZE</small> D
	HORNBECK OFFSHORE SERVICES			
OUTBOARD PROFILE & GENERAL ARRANGEMENT		<small>TASK No.</small> 7582	<small>DRAWING No.</small> 1.001	<small>SCALE: 3/32" = 1'-0"</small>
		<small>HULL No. 248</small>	<small>SY: NAS</small>	<small>DATE: 05/22/23</small> <small>SHEET 3 OF 3</small>